







MB300/330/400

THE ESSENTIAL 3D WHEEL BALANCERS WITH QUALITY PERFORMANCES AND A SPACE SAVING DESIGN



MB300

-  M&B MB300 is the simple and intuitive digital balancing machine which ensures efficiency with reduced dimensions
-  M&B MB300 è l'equilibratrice digitale semplice e intuitiva che garantisce resa ed efficienza con dimensioni ridotte
-  M&B MB300 est l'équilibratrice numérique simple et intuitive qui garantit rendement et efficacité avec dimensions réduites
-  M&B MB300 ist eine einfache und intuitive digitale Auswuchtmaschine, die bei kleineren Abmessungen Leistung und Effizienz garantiert
-  M&B MB300 es la equilibradora digital sencilla e intuitiva que asegura rendimiento y eficiencia con dimensiones reducidas



MB300

WHEEL GUARD	GRAPHIC INTERFACE	DISTANCE AND DIAMETER MEASURING	WIDTH MEASURING	WHEEL LOCKING	ELECTROMAGNETIC BRAKE	LASER LINE
OPTIONAL (Non-retrofit - Factory assembled)	Display panel	with automatic gauge	with Virtual Sonar	Manual	Not available	Not available

STANDARD CONFIGURATION



INNOVATIVE SOFTWARE



The Virtual Sonar software enables, in absence of a sonar device, to detect the rim width of steel rims without having to enter them in manually. Reduces balancing time by avoiding operator errors caused by manual data entries



AutoAdaptive software detects wheel weight and dimensions and calculates the tolerance value that will cancel any vibration perceived on the steering wheel, granting the highest comfort when driving

- Automatic gauge** for a correct measurement of distance and diameter and self-activation of the ideal balancing program (clip-on or stick-on weights)
Virtual Sonar to acquire automatically the 3D width of iron rims, with the same performance of the traditional Sonar technology
Innovative **AutoAdaptive software** to recalculate the acceptable unbalance value according to the weight and dimensions of each wheel
Display panel with immediate interface to ease the operation
Intuitive and user-friendly **interface** to ease the operation
Work optimisation thanks to reduced balancing times
Low rotation speed with subsequent power save
Space-saving wheel guard (for MB300 wheel guard available upon request)
Electric brake to lock the wheel and to ease the application of weights (only MB330/MB400 models)
Laser line to ease the application of weights (only MB400)
- Calibro automatico** per la corretta misura di distanza e diametro
Virtual Sonar per acquisire automaticamente la larghezza 3D dei cerchi in ferro, con le stesse prestazioni della tecnologia Sonar tradizionale
Innovativo **Software AutoAdaptive** per ricalcolare il valore di squilibrio accettabile in base al peso e alla geometria di ogni singola ruota
Interfaccia immediata e di facile utilizzo per facilitare le operazioni
Ottimizzazione del lavoro grazie ai tempi di equilibratura ridotti
Bassa velocità di rotazione con conseguente risparmio energetico
Protezione ruota salva-spazio (per MB300 protezione ruota disponibile su richiesta)
Freno elettrico per bloccare la ruota e agevolare l'applicazione dei pesi (solo modelli MB330/MB400)
Linea laser per agevolare l'applicazione dei pesi (solo MB400)
- Calibrage automatique** pour la mesure correcte de la distance et du diamètre
Virtual Sonar pour acquérir automatiquement la largeur 3D des jantes en fer, avec les mêmes performances de la technologie Sonar traditionnelle
Logiciel AutoAdaptive innovant pour recalculer la valeur de balourd acceptable en fonction du poids et de la géométrie de chaque roue
Interface immédiate et **intuitif** pour faciliter les opérations
Optimisation du travail grâce aux temps d'équilibrage réduits
Basse vitesse de rotation avec une économie d'énergie en découlant
Protection roue peu encombrante (pour MB300 protection roue disponible sur demande)
Frein électrique pour bloquer la roue et faciliter l'application des masses (uniquement modèles MB330/MB400)
Ligne laser pour faciliter l'application des masses (MB400)
- Automatischer Messlehre** zur korrekten Messung von Abstand und Durchmesser bis 30 Zoll. und Selbstaktivierung von Klebegewichte- oder Stahlgewichte- Programm
Virtual Sonar zur automatischen Erfassung der 3D-Breite von Eisenfelgen mit der gleichen Leistung wie bei der herkömmlichen Sonar-Technologie
Innovative **AutoAdaptive-Software** zur Neuberechnung des akzeptablen Ungleichgewichts basierend auf dem Gewicht und der Geometrie jedes einzelnen Rads
Sofortiger Benutzeroberfläche und zur intuitive Erleichterung der Bedienung
Arbeitsoptimierung durch verkürzte Auswuchtzeiten
Niedrige Drehzahl mit entsprechender Energieeinsparung
Platzsparender Radschutz (MB300: Radschutz auf Anfrage erhältlich)
Elektrische Bremse zum Blockieren des Rads und das Anbringen der Gewichte zu erleichtern (nür MB330/MB400)
Laserlinie um das Anbringen der Gewichte zu erleichtern (nür MB400)
- Calibre automático** para una medición correcta de distancia y diámetro
Virtual Sonar par adquirir automáticamente la longitud 3D de las llantas de hierro, con las mismas prestaciones de la tecnología Sonar tradicional
Software AutoAdaptive innovador para volver a calcular el valor de desequilibrio aceptable de acuerdo con el peso y la geometría de cada rueda
Interfaz inmediata y intuitiva para facilitar las operaciones
Optimización del trabajo gracias a los tiempos reducidos de equilibrado
Baja velocidad de rotación con consecuente ahorro energético
Protección rueda ahorra-espacio (MB300: protección rueda disponible bajo solicitud)
Freno eléctrico para bloquear la rueda y facilitar la aplicación de los contrapesos (solo MB330/ MB400)
Línea láser para facilitar la aplicación de los contrapesos (solo MB400)

MB330

- 🇬🇧 M&B MB330 is the digital compact balancing machine with innovative and high accuracy features
- 🇮🇹 M&B MB330 è l'equilibratrice digitale compatta con funzioni innovative e di elevata precisione
- 🇫🇷 M&B MB330 est l'équilibreuse numérique compacte avec fonctions innovantes et de haute précision
- 🇩🇪 M&B MB330 ist die kompakte digitale Auswuchtmaschine mit innovativen und hochpräzise Funktionen
- 🇪🇸 M&B MB330 es la equilibradora digital compacta con funciones innovadoras y de alta precisión

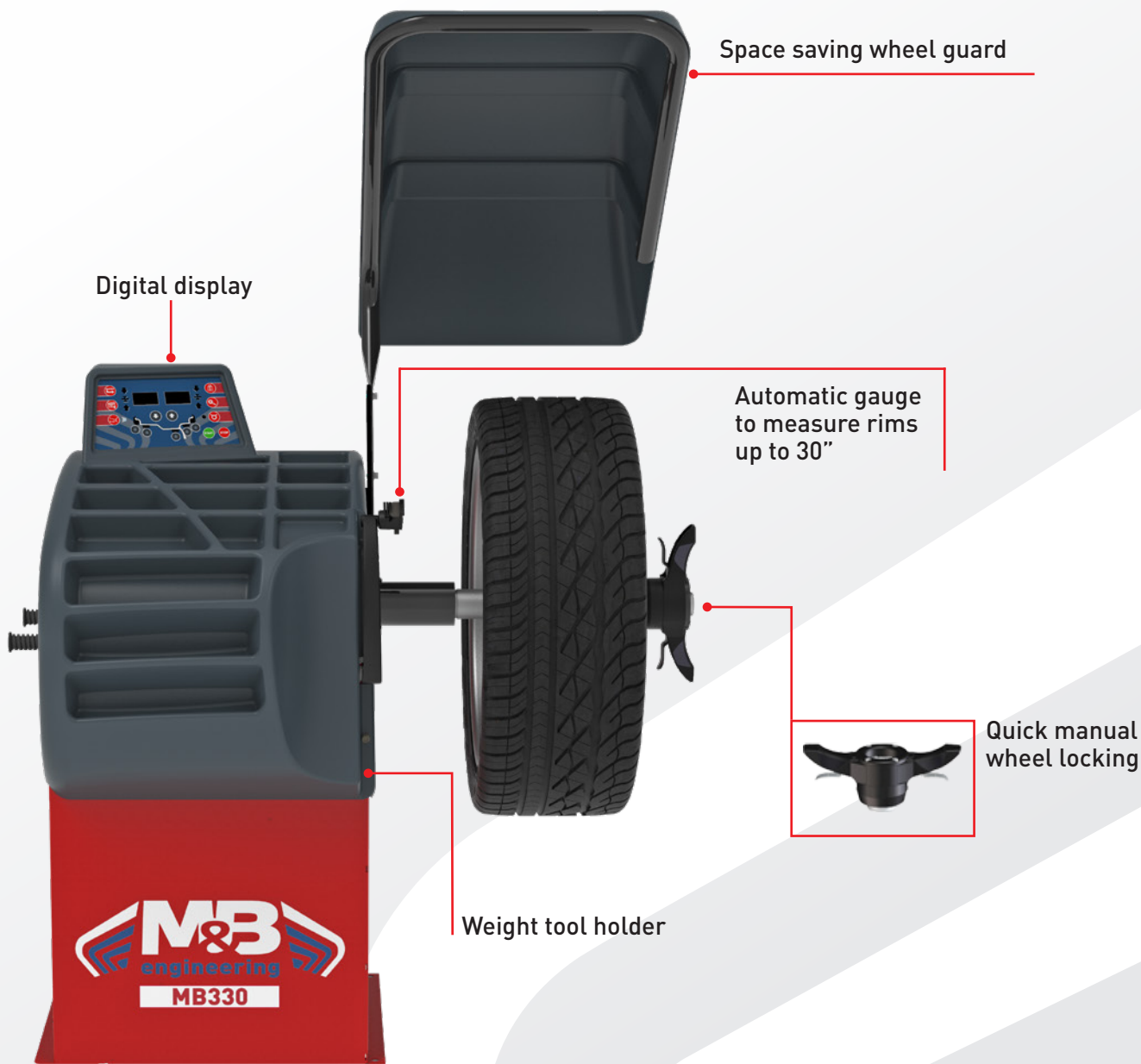





	WHEEL GUARD	GRAPHIC INTERFACE	DISTANCE AND DIAMETER MEASURING	WIDTH MEASURING	WHEEL LOCKING	ELECTROMAGNETIC BRAKE	LASER LINE
MB330	Standard	Display panel	with automatic gauge	with Virtual Sonar	Manual	Standard	Not available

STANDARD CONFIGURATION



MB400

-  M&B MB400 is the computerized electronic balancing machine that combines enhanced performance with reduced size
-  M&B MB400 è l'equilibratrice elettronica computerizzata che unisce prestazioni avanzate a ingombri contenuti
-  M&B MB400 est l'équilibruse électronique informatisée qui unit des performances avancées à des encombrements contenus
-  M&B MB400 ist das computergesteuerte elektronische Auswuchtgerät das fortschrittliche Leistung mit kleinen Abmessungen kombiniert
-  M&B MB400 es la equilibradora electrónica computerizada que une prestaciones avanzadas a un tamaño reducido



MB400

WHEEL GUARD	GRAPHIC INTERFACE	DISTANCE AND DIAMETER MEASURING	WIDTH MEASURING	WHEEL LOCKING	ELECTROMAGNETIC BRAKE	LASER LINE
Standard	Display panel	with automatic gauge	with Virtual Sonar	Manual	Standard	Standard

STANDARD CONFIGURATION



OPTIONAL ACCESSORIES

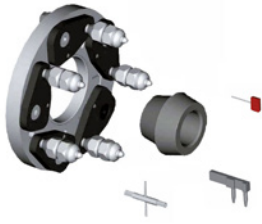

UH20/2 Ø 40
Universal adapter 3-4-5-6 hole



RL cup Ø 40
with rubber ring for alloy rims protection

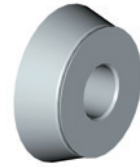

J cone Ø 40
for cross-country and
4WD wheels range Ø 101÷119 mm



WD spacer Ø 40
(Spacer for wide wheels) + DC spacer
Ø 40 (to use together with WD)



VL/2 cone Ø 40
Large cone for light truck 97÷180 mm



Special cone Ø 40 for central
hole Ø 89/132 mm



Professional automatic wheel lift
capacity 80 kg

OVERALL DIMENSIONS

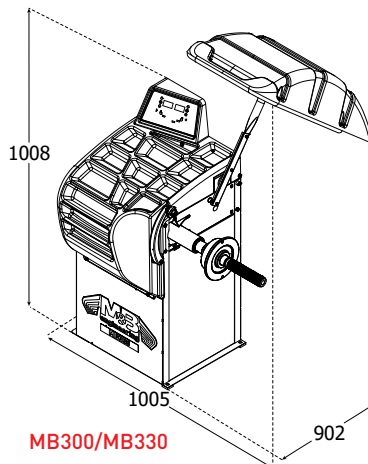

MB300/MB330

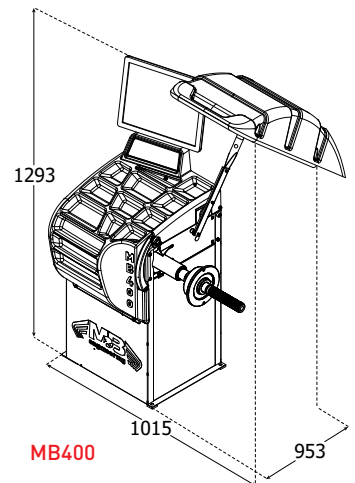

MB400

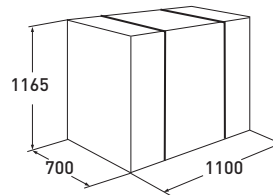

TECHNICAL DATA

110 kg	10" ÷ 30" 265 ÷ 765 mm	1.5" ÷ 20" 40 ÷ 510 mm	20" 508 mm	40" 1120 mm	< 75 kg	230V/1/50-60 Hz 115V/1/60 Hz	100 rpm	0,15



M&B ENGINEERING SRL
Via Nobel, 21 - 42124 Reggio Emilia (RE)
info@mb-re.it - www.mbenengineering.info